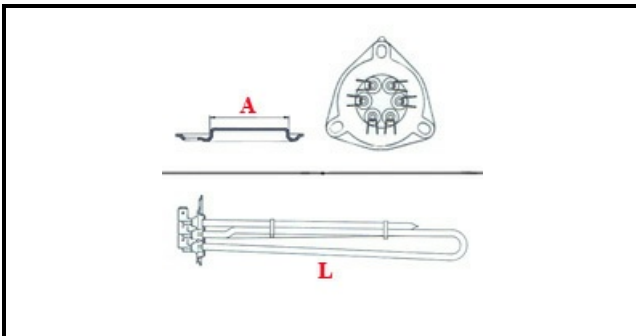

1201063

BOOSTER HEATING

Date: 19-09-2024

ORIGINAL
OSP
SPARE PARTS**Technical data**

| | |
|-------------------------------|---------------------------------------|
| DEPTH MM | L=500mm |
| WIDTH MM | A=47mm |
| ELEMENTS | ELEMENTI/ELEMENTS=3 |
| TRIANGULAR FLANGE | TRIANGOLARE/TRIANGULAR FLANGE=47mm |
| DIAMETER mm | A=47mm |
| KILOWATT KW | KW=10,62 |
| WATT | WATT=10620 |
| THREE PHASE | TRIFASE/THREEPHASE |
| NUMBER OF POLES | POLI/POLES=6 |
| NUMBER OF HOLES | FORI/HOLES=3 |
| GASKET | 2101032 |
| IMMERSION HEATING ELEMENTS | IMMERSIONE/IMMERSION |

Manufacturer code

HOBART GmbH