

1101064

HEATING ELEMENT 2700W 220V 2 GR

Date: 09-04-2025



ORIGINAL
OSP
SPARE PARTS

Technical data

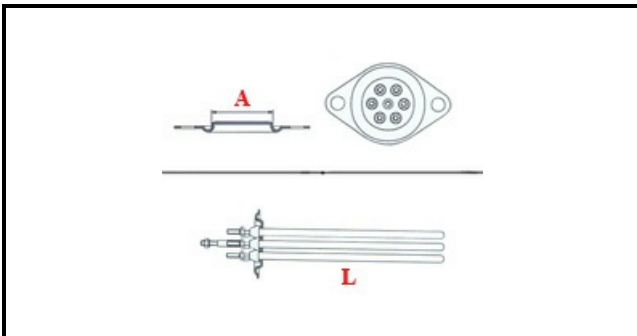

DEPTH MM	L=300mm
WIDTH MM	A=42mm
ELEMENTS	ELEMENTI/ELEMENTS=3
ROUND FLANGE	TONDA/ROUND FLANGE=42mm
DIAMETER mm	A=42mm
KILOWATT KW	KW=2,7
WATT	WATT=2700
THREE PHASE	TRIFASE/THREEPHASE
NUMBER OF POLES	POLI/POLES=6
NUMBER OF HOLES	FORI/HOLES=2
GASKET	2102130
IMMERSION HEATING ELEMENTS	IMMERSIONE/IMMERSION ELEMENTS

Manufacturer code

S.V. ITALIA SRL

ASTORIA MC SRL