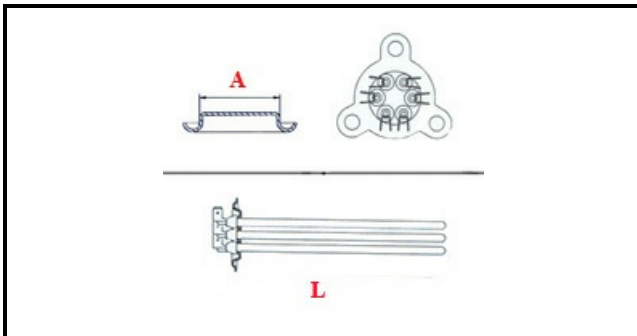

1101018

**BOILER HEATING ELEMENT SAB 4000W**

Date: 27-01-2025

**Technical data**

DEPTH MM	L=290mm
ELEMENTS	ELEMENTI/ELEMENTS=3
TRIANGULAR FLANGE	TRIANGOLARE/TRIANGULAR FLANGE=38mm
DIAMETER mm	A=38mm
KILOWATT KW	KW=4,0
WATT	WATT=4000
THREE PHASE	TRIFASE/THREEPHASE
NUMBER OF POLES	POLI/POLES=6
NUMBER OF HOLES	FORI/HOLES=3
GASKET	2101031
IMMERSION HEATING ELEMENTS	IMMERSIONE/IMMERSION

**Manufacturer code**

RANCILIO GROUP SPA CON SOCIO UNICO

S.V. ITALIA SRL