

1201153

HEATING ELEMENT 3000W

Date: 23-01-2025

ORIGINAL
OSP
SPARE PARTS

Technical data

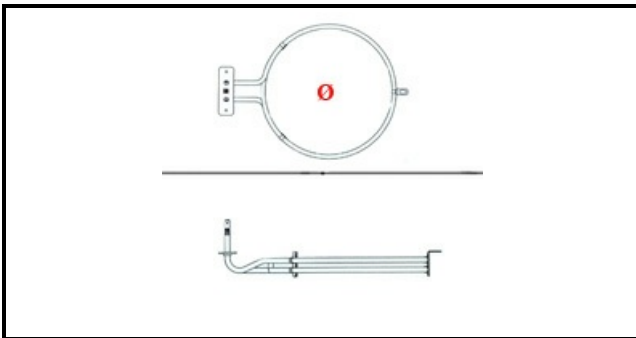

ELEMENTS	ELEMENTI/ELEMENTS=1
KILOWATT KW	KW=3
WATT	WATT=3000
MONOPHASE	MONOFASE/MONOPHASE
NUMBER OF POLES	POLI/POLES=2
DRY HEATING ELEMENT	SECCO/DRY

Manufacturer code

FIMAR s.p.a.