

1106103

# SAFETY THERMOSTAT 350° C SINGLE PHASE- SENSOR Ø 14X16 mm CAPILLARY 900mm

Date: 22-12-2024



## Technical data

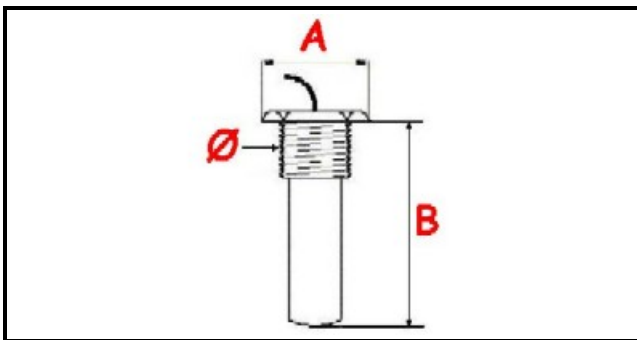

MONOPHASE	MONOFASE/MONOPHASE
GAS THREAD	Ø=14mm
NUMBER OF POLES	POLI/POLES=2
MAXIMUM TEMPERATURE °	T max=350°
WIRE mm	L=900mm
PROBE DIAMETER MM	A=24mm
PROBE LENGHT MM	B=12mm

## Manufacturer code

E.G.O. ELEKTRO GERATE AG

ANGELO PO GRANDI CUCINE SPA

ELECTROLUX PROFESSIONAL S.P.A.