

1105481

SWITCH BIPOLAR 16A COMPLET

Date: 23-02-2025



Technical data

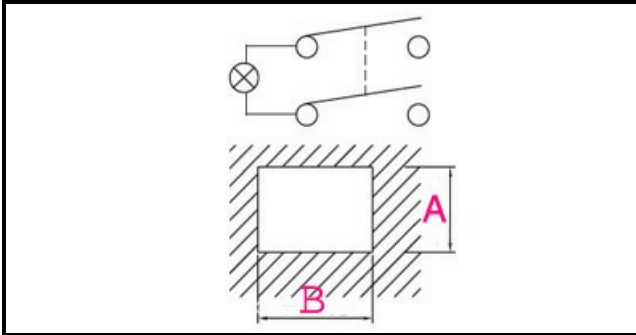

DEPTH MM	A=22mm
WIDTH MM	B=30mm
NUMBER OF POLES	POLI/POLES=4
NUMBER OF POSITIONS	2
COLOR	BIANCO/WHITE
VOLT	230V

Manufacturer code

MACAP SRL
