

1105487

Date: 15-11-2024

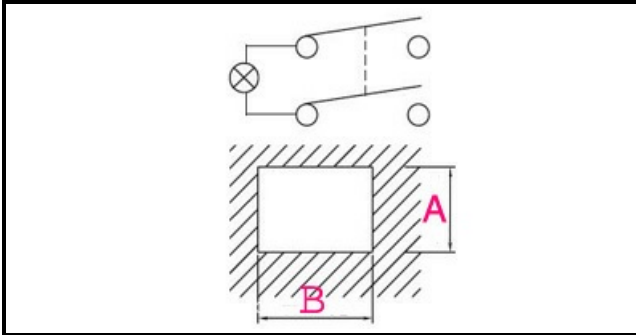

Technical data



DEPTH MM	A=22mm
WIDTH MM	B=28mm
NUMBER OF POLES	POLI/POLES=4
NUMBER OF POSITIONS	2
VOLT	250V

Manufacturer code

SCOTSMAN ICE Srl.