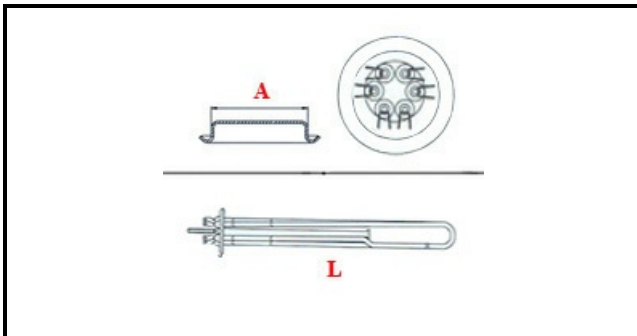

1101215

HEATING ELEMENT 5000W 230V

Date: 22-11-2024

ORIGINAL
OSP
SPARE PARTS**Technical data**

DEPTH MM	L=250mm
ELEMENTS	ELEMENTI/ELEMENTS=3
ROUND FLANGE	TONDA/ROUND FLANGE=47mm
DIAMETER mm	A=47mm
KILOWATT KW	KW=5
WATT	WATT=5000
THREE PHASE	TRIFASE/THREEPHASE
NUMBER OF POLES	POLI/POLES=6
GASKET	2101032
IMMERSION HEATING ELEMENTS	IMMERSIONE/IMMERSION

Manufacturer code

COMENDA - ALI GROUP SRL A SOCIO UNICO