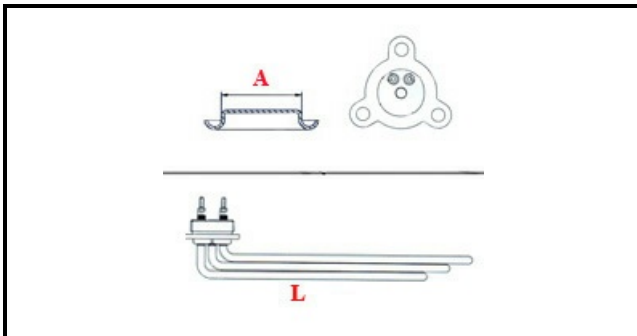

1101496

**TANK HEATING ELEMENT 2500W**

Date: 30-01-2025

ORIGINAL  
**OSP**  
SPARE PARTS**Technical data**

DEPTH MM	L=310mm
ELEMENTS	ELEMENTI/ELEMENTS=1
TRIANGULAR FLANGE	TRIANGOLARE/TRIANGULAR FLANGE=37mm
DIAMETER mm	A=37mm
KILOWATT KW	KW=2,5
WATT	WATT=2500
MONOPHASE	MONOFASE/MONOPHASE
NUMBER OF POLES	POLI/POLES=2
NUMBER OF HOLES	FORI/HOLES=3
GASKET	2101031
IMMERSION HEATING ELEMENTS	IMMERSIONE/IMMERSION

**Manufacturer code**

KRUPPS S.R.L.