

1101673

HEATING ELEMENT 230V 14000W

Date: 24-11-2024

ORIGINAL
OSP
SPARE PARTS

Technical data

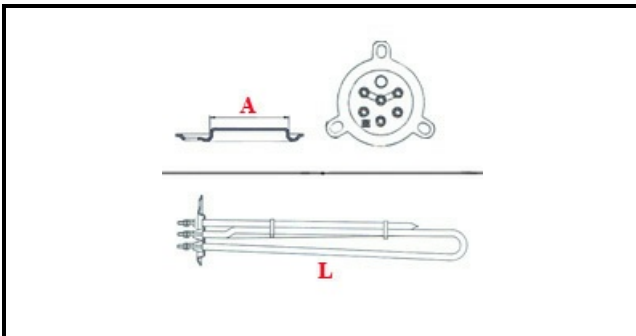

DEPTH MM	L=480mm
ELEMENTS	ELEMENTI/ELEMENTS=3
TRIANGULAR FLANGE	TRIANGOLARE/TRIANGULAR FLANGE=62mm
DIAMETER mm	A=62mm
KILOWATT KW	KW=14
WATT	WATT=14000
THREE PHASE	TRIFASE/THREEPHASE
NUMBER OF POLES	POLI/POLES=6
NUMBER OF HOLES	FORI/HOLES=3
GASKET	2101058
IMMERSION HEATING ELEMENTS	IMMERSIONE/IMMERSION

Manufacturer code

ARISTARCO / KASTEL S.P.A.
KRUPPS S.R.L.
ARISTARCO / KASTEL S.P.A.