

1101771

# HEATING ELEMENT 230V 4500W

Date: 22-11-2024

ORIGINAL  
**OSP**  
SPARE PARTS

## Technical data

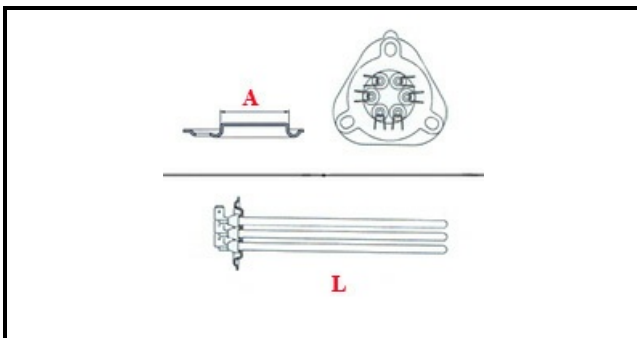

DEPTH MM	L=260mm
ELEMENTS	ELEMENTI/ELEMENTS=3
TRIANGULAR FLANGE	TRIANGOLARE/TRIANGULAR FLANGE=47mm
DIAMETER mm	A=47mm
KILOWATT KW	KW=4,5
WATT	WATT=4500
THREE PHASE	TRIFASE/THREEPHASE
NUMBER OF POLES	POLI/POLES=6
NUMBER OF HOLES	FORI/HOLES=3
GASKET	2101032
IMMERSION HEATING ELEMENTS	IMMERSIONE/IMMERSION

## Manufacturer code

ELECTROLUX PROFESSIONAL S.P.A.

ELECTROLUX PROFESSIONAL S.P.A.