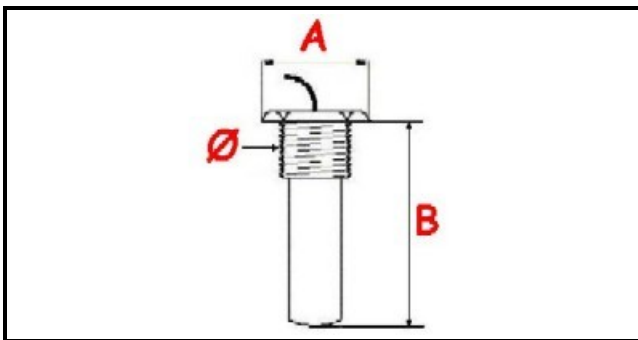

1106081

**FIXED THERMOSTAT 60° SINGLE PHASE - SENSOR Ø 17X48 mm
CAPILLARY 610mm**

Date: 27-02-2025

**Technical data**

MONOPHASE	MONOFASE/MONOPHASE
GAS THREAD	Ø=17mm
NUMBER OF POLES	POLI/POLES=3
MAXIMUM TEMPERATURE °	T max=60°
WIRE mm	L=610mm
PROBE DIAMETER MM	A=21mm
PROBE LENGHT MM	B=48mm
GASKET	2102214
NUT	1141248

Manufacturer code

ELFRAMO SPA

ELFRAMO SPA