

1101280

HEATING ELEMENT 230V 6000W

Date: 24-11-2024



ORIGINAL
OSP
SPARE PARTS

Technical data

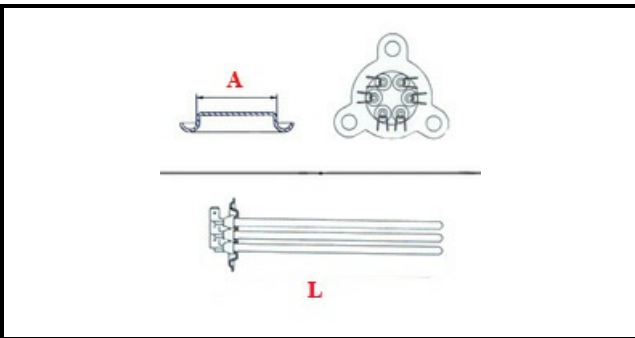

DEPTH MM	L=350mm
ELEMENTS	ELEMENTI/ELEMENTS=3
TRIANGULAR FLANGE	TRIANGOLARE/TRIANGULAR FLANGE=61mm
DIAMETER mm	A=61mm
KILOWATT KW	KW=6
WATT	WATT=6000
THREE PHASE	TRIFASE/THREEPHASE
NUMBER OF POLES	POLI/POLES=6
NUMBER OF HOLES	FORI/HOLES=3
GASKET	2101058
IMMERSION HEATING ELEMENTS	IMMERSIONE/IMMERSION

Manufacturer code

ARISTARCO / KASTEL S.P.A.
ARISTARCO / KASTEL S.P.A.
ARISTARCO / KASTEL S.P.A.
ARISTARCO / KASTEL S.P.A.