

1101926

HEATING ELEMENT 9KW 240V-380V

Date: 24-11-2024

ORIGINAL
OSP
SPARE PARTS

Technical data

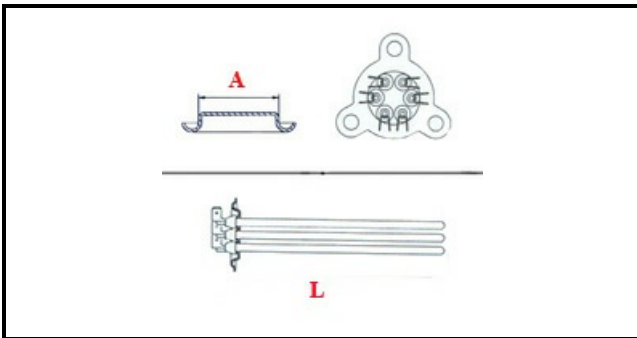

DEPTH MM	L=447mm
ELEMENTS	ELEMENTI/ELEMENTS=3
TRIANGULAR FLANGE	TRIANGOLARE/TRIANGULAR FLANGE=62mm
DIAMETER mm	A=62mm
KILOWATT KW	KW=9
WATT	WATT=9000
THREE PHASE	TRIFASE/THREEPHASE
NUMBER OF POLES	POLI/POLES=6
NUMBER OF HOLES	FORI/HOLES=3
GASKET	2101058
IMMERSION HEATING ELEMENTS	IMMERISONE/IMMERSION

Manufacturer code

ARISTARCO / KASTEL S.P.A.

ARISTARCO / KASTEL S.P.A.