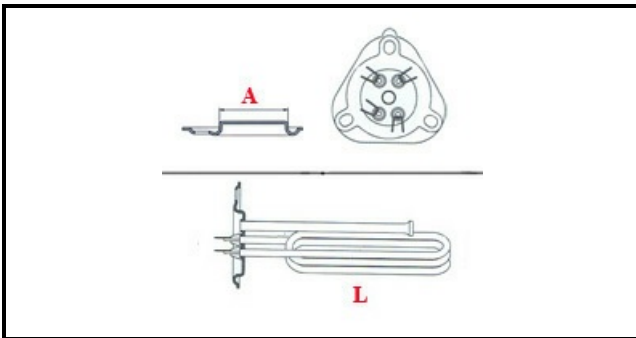

1101217

MONOPHASE HEATING ELEMENT 3200W 230V

Date: 08-01-2025

ORIGINAL
OSP
SPARE PARTS**Technical data**

DEPTH MM	L=240mm
ELEMENTS	ELEMENTI/ELEMENTS=2
TRIANGULAR FLANGE	TRIANGOLARE/TRIANGULAR FLANGE=46mm
DIAMETER mm	A=46mm
KILOWATT KW	KW=3,2
WATT	WATT=3200
MONOPHASE	MONOFASE/MONOPHASE
NUMBER OF POLES	POLI/POLES=4
NUMBER OF HOLES	FORI/HOLES=3
GASKET	2101032
IMMERSION HEATING ELEMENTS	IMMERSIONE/IMMERSION

Manufacturer code

COMENDA - ALI GROUP SRL A SOCIO UNICO