

1101218

## THREE-PHASE HEATING ELEMENT 5000W 230V BHC

Date: 23-11-2024



### Technical data

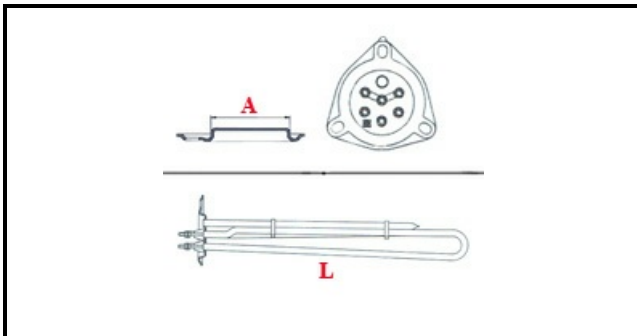

DEPTH MM	L=260mm
ELEMENTS	ELEMENTI/ELEMENTS=3
TRIANGULAR FLANGE	TRIANGOLARE/TRIANGULAR FLANGE=47mm
DIAMETER mm	A=47mm
KILOWATT KW	KW=5
WATT	WATT=5000
THREE PHASE	TRIFASE/THREEPHASE
NUMBER OF POLES	POLI/POLES=6
NUMBER OF HOLES	FORI/HOLES=3
GASKET	2101032
IMMERSION HEATING ELEMENTS	IMMERSIONE/IMMERSION ELEMENTS

### Manufacturer code

HOONVED - ALI GROUP SRL A SOCIO UNICO
LASA SRL
ELETTROBAR EUROTEC SRL
COMENDA - ALI GROUP SRL A SOCIO UNICO
SMEG SPA