

1101286

HEATING ELEMENT 10000W 230/400V CMND

Date: 23-11-2024

**ORIGINAL
OSP
SPARE PARTS**

Technical data

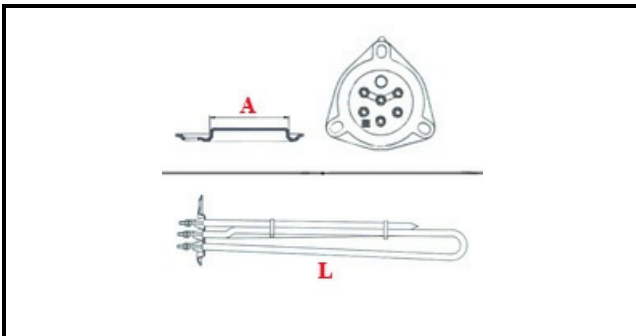

DEPTH MM	L=480mm
ELEMENTS	ELEMENTI/ELEMENTS=3
TRIANGULAR FLANGE	TRIANGOLARE/TRIANGOLARE FLANGE=57mm
DIAMETER mm	A=57mm
KILOWATT KW	KW=10
WATT	WATT=10000
THREE PHASE	TRIFASE/THREEPHASE
NUMBER OF POLES	POLI/POLES=6
NUMBER OF HOLES	FORI/HOLES=3
GASKET	2101033
IMMERSION HEATING ELEMENTS	IMMERSIONE/IMMERSION

Manufacturer code

ANGELO PO GRANDI CUCINE SPA
COMENDA - ALI GROUP SRL A SOCIO UNICO
COMENDA - ALI GROUP SRL A SOCIO UNICO
COMENDA - ALI GROUP SRL A SOCIO UNICO
COMENDA - ALI GROUP SRL A SOCIO UNICO