

1101620

HEATING ELEMENT 6000W 230/400 FL57XL350

Date: 11-03-2025



Technical data

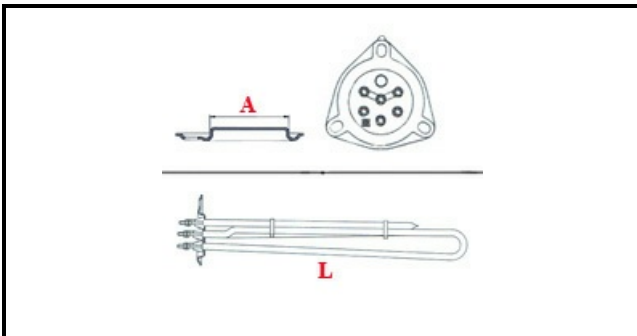

DEPTH MM	L=350mm
ELEMENTS	ELEMENTI/ELEMENTS=3
TRIANGULAR FLANGE	TRIANGOLARE/TRIANGULAR FLANGE=57mm
DIAMETER mm	A=57mm
KILOWATT KW	KW=6
WATT	WATT=6000
THREE PHASE	TRIFASE/THREEPHASE
NUMBER OF POLES	POLI/POLES=6
NUMBER OF HOLES	FORI/HOLES=3
GASKET	2101033
IMMERSION HEATING ELEMENTS	IMMERSIONE/IMMERSION ELEMENTS

Manufacturer code

KRUPPS S.R.L.
COMENDA - ALI GROUP SRL A SOCIO UNICO
ANGELO PO GRANDI CUCINE SPA
OMNIWASH GROUP SRL
HOONVED - ALI GROUP SRL A SOCIO UNICO