

1106713

THERMOSTAT 338°C THREEPHASE SAFETY - SENSOR Ø 10X50 mm CAPILLARY 800mm

Date: 27-12-2024

ORIGINAL
OSP
SPARE PARTS

Technical data

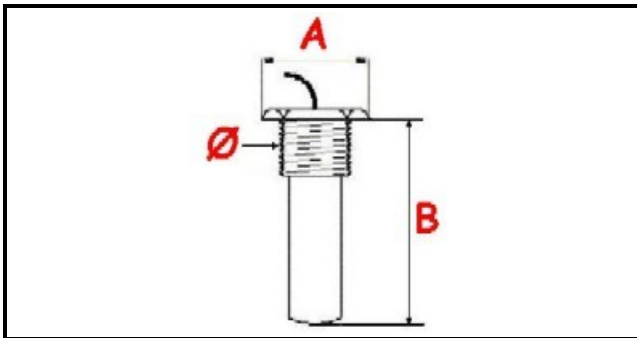

THREE PHASE	TRIFASE/THREE PHASE
GAS THREAD	Ø=10mm
NUMBER OF POLES	POLI/POLES=5
MAXIMUM TEMPERATURE °	T max=338°
WIRE mm	L=900mm
PROBE LENGHT MM	B=53mm

Manufacturer code

ELECTROLUX PROFESSIONAL S.P.A.

E.G.O. ELEKTRO GERATE AG