

9501016

1321187013 BELLOWS SEAL, PORTHOLE, P

Date: 29-01-2025



Technical data

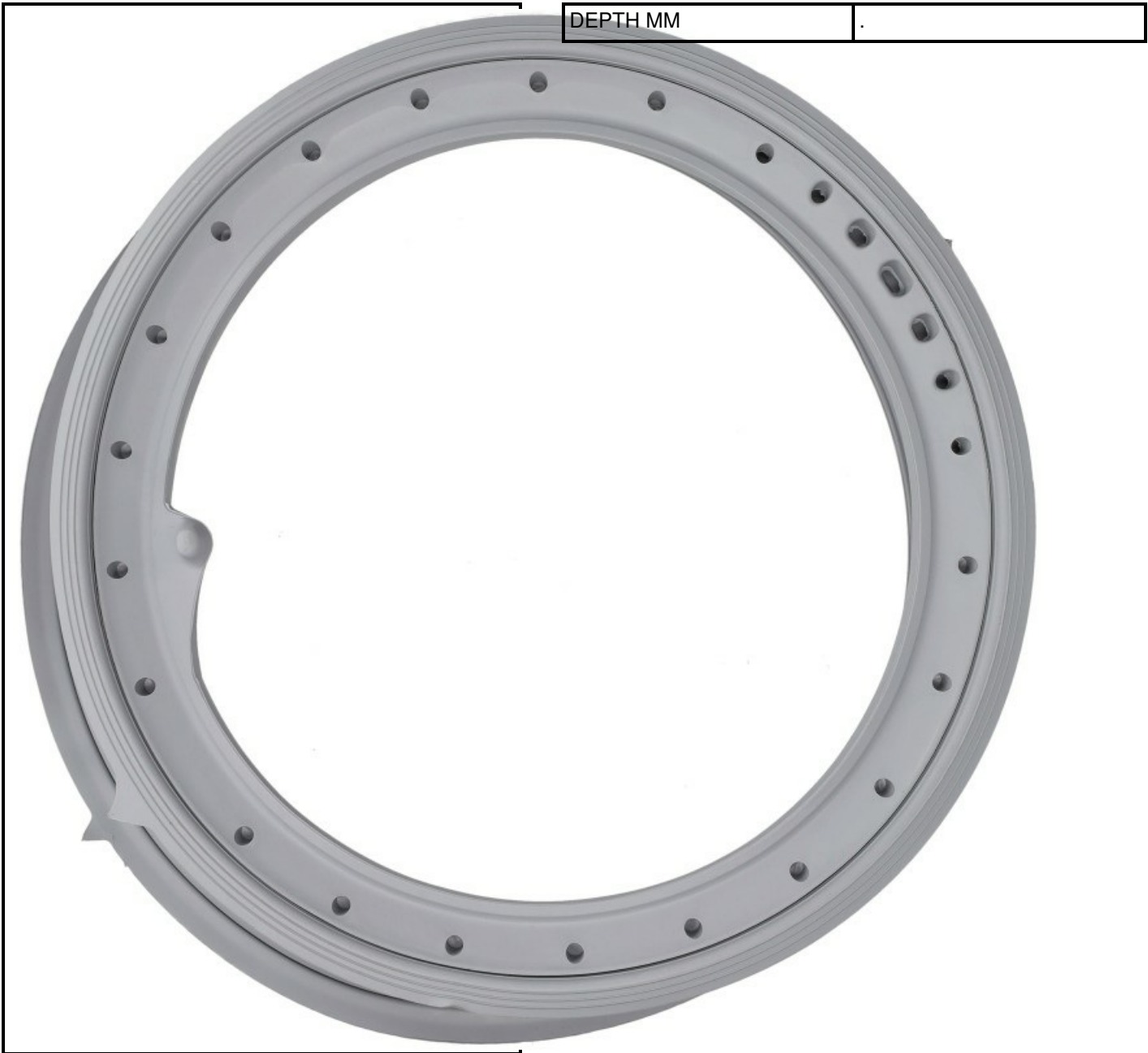

Manufacturer code

ELECTROLUX - REX APPLIANCES SPA
