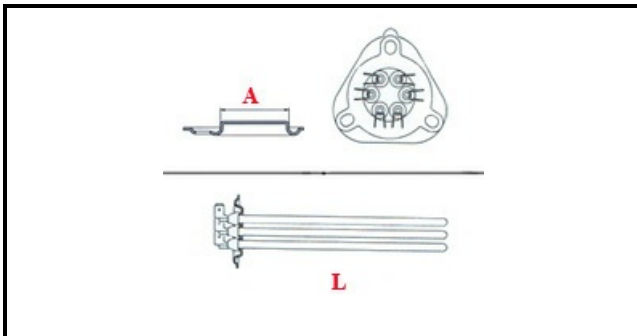

1101423

BOILER ELEMENT 4500W 230V

Date: 24-11-2024

ORIGINAL
OSP
SPARE PARTS**Technical data**

DEPTH MM	L=225mm
ELEMENTS	ELEMENTI/ELEMENTS=3
TRIANGULAR FLANGE	TRIANGOLARE/TRIANGULAR FLANGE=47mm
DIAMETER mm	A=47mm
KILOWATT KW	KW=4,5
WATT	WATT=4500
THREE PHASE	TRIFASE/THREEPHASE
NUMBER OF POLES	POLI/POLES=6
NUMBER OF HOLES	FORI/HOLES=3
GASKET	2101032
IMMERSION HEATING ELEMENTS	IMMERSIONE/IMMERSION

Manufacturer code

ELECTROLUX PROFESSIONAL S.P.A.