

1106891

SAFETY THERMOST 220°C-18 THREEPHASES

Date: 22-11-2024

ORIGINAL
OSP
SPARE PARTS

Technical data

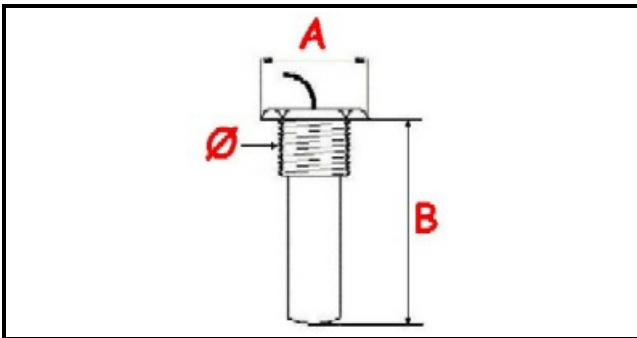

THREE PHASE	TRIFASE/THREEPHASE
THREAD MA	Ø=14mm
NUMBER OF POLES	POLI/POLES=6
MAXIMUM TEMPERATURE °	Tmax=220°C
WIRE mm	L=1450mm
PROBE DIAMETER MM	A=10mm

Manufacturer code

ELFRAMO SPA

E.G.O. ELEKTRO GERATE AG