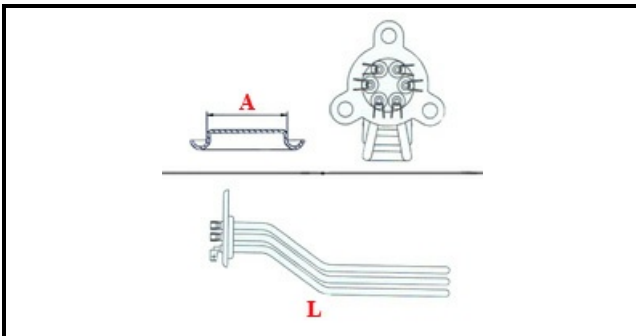

1101077

BOILER/TANK HEATING ELEMENT 6KW

Date: 31-01-2025

ORIGINAL
OSP
SPARE PARTS**Technical data**

DEPTH MM	L=365mm
ELEMENTS	ELEMENTI/ELEMENTS=3
TRIANGULAR FLANGE	TRIANGOLARE/TRIANGULAR FLANGE=37mm
DIAMETER mm	A=37mm
KILOWATT KW	KW=6
WATT	WATT=6000
THREE PHASE	TRIFASE/THREEPHASE
NUMBER OF POLES	POLI/POLES=6
NUMBER OF HOLES	FORI/HOLES=3
GASKET	2101031
IMMERSION HEATING ELEMENTS	IMMERSIONE/IMMERSION

Manufacturer code

HOONVED - ALI GROUP SRL A SOCIO UNICO

SILANOS SRL