

1201101

# HEATING ELEMENT ROTATING FOR CP70 7800W 3-230V

Date: 22-11-2024

ORIGINAL  
**OSP**  
SPARE PARTS

## Technical data

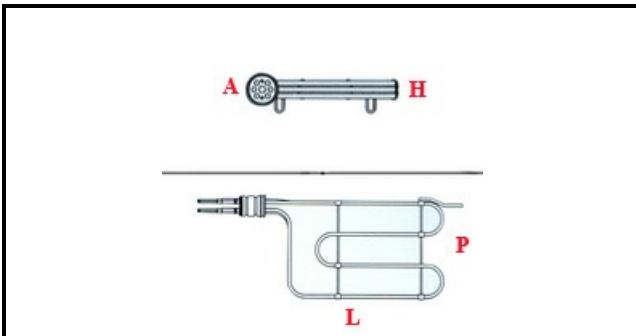

DEPTH MM	L=290mm
WIDTH MM	P=190mm
ELEMENTS	ELEMENTI/ELEMENTS=3
ROUND FLANGE	TONDA/ROUND FLANGE=60mm
DIAMETER mm	A=60mm
KILOWATT KW	KW=7,8
WATT	WATT=7800
MONOPHASE	MONOFASE/MONOPHASE
NUMBER OF POLES	POLI/POLES=6
IMMERSION HEATING ELEMENTS	IMMERSIONE/IMMERSION
THREADED FLANGE	2"

## Manufacturer code

LOTUS SPA
LOTUS SPA