

1105481

## SWITCH BIPOLAR 16A COMPLET

Date: 25-11-2024



**Technical data**

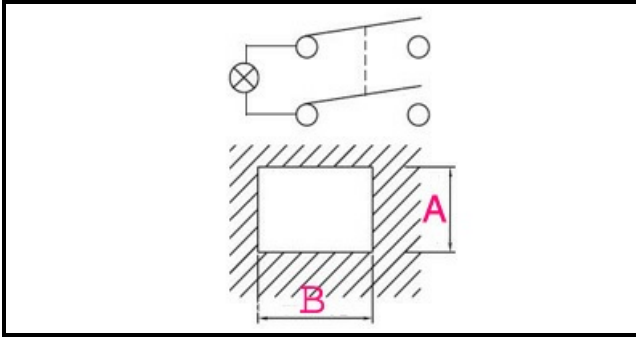

DEPTH MM	A=22mm
WIDTH MM	B=30mm
NUMBER OF POLES	POLI/POLES=4
NUMBER OF POSITIONS	2
COLOR	BIANCO/WHITE
VOLT	230V

## Manufacturer code

MACAP SRL
-----------