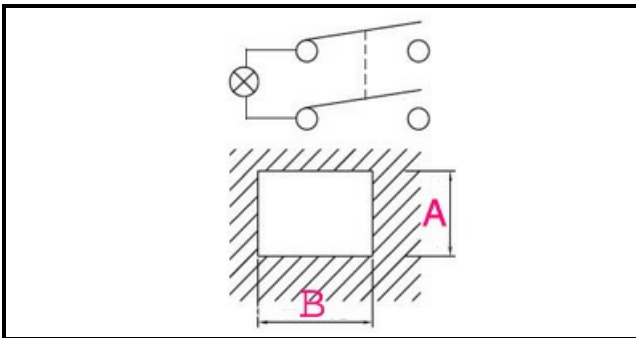

1105002

COFFEE SWITCH WITH LED

Date: 23-11-2024

ORIGINAL
OSP
SPARE PARTS**Technical data**

DEPTH MM	B=30mm
WIDTH MM	A=22mm
NUMBER OF POLES	POLI/POLES=4
NUMBER OF POSITIONS	0-1
COLOR	NERO CON LED/BLACK WITH LED
VOLT	250V

Manufacturer code

MAGISTER SISTEMA CAFFE' SRL
RANCILIO GROUP SPA CON SOCIO UNICO