

1101642

FRYER HEATING ELEMENT 16500W 90 1GOL6P387001

Date: 22-11-2024



ORIGINAL
OSP
SPARE PARTS

Technical data

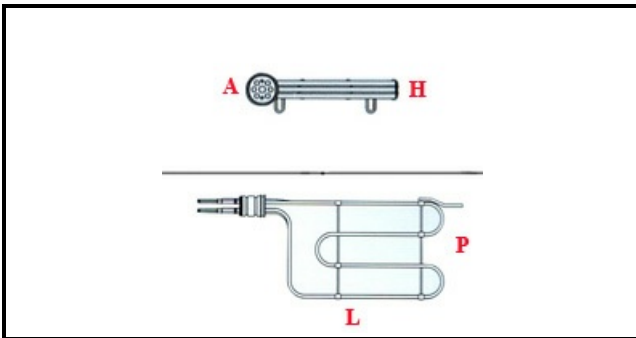

DEPTH MM	L=400mm
WIDTH MM	P=305mm
ELEMENTS	ELEMENTI/ELEMENTS=3
ROUND FLANGE	TONDA/ROUND FLANGE=2"
DIAMETER mm	A=60mm
KILOWATT KW	KW=16,5
WATT	WATT=16500
THREE PHASE	TRIFASE/THREEPHASE
NUMBER OF POLES	POLI/POLES=6
IMMERSION HEATING ELEMENTS	IMMERSIONE/IMMERSION

Manufacturer code

SILKO ALI GROUP SRL A SOCIO UNICO
MARENO ALI GROUP SRL A SOCIO UNICO
MARENO ALI GROUP SRL A SOCIO UNICO
SILKO ALI GROUP SRL A SOCIO UNICO