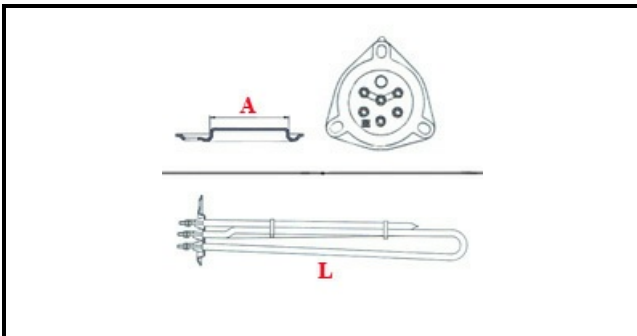

1101158

HEATING ELEMENT 4500W 380/230V D. 58X350L

Date: 23-11-2024

**Technical data**

DEPTH MM	L=350mm
ELEMENTS	ELEMENTI/ELEMENTS=3
TRIANGULAR FLANGE	TRIANGOLARE/TRIANGULAR FLANGE=57mm
DIAMETER mm	A=57mm
KILOWATT KW	KW=4,5
WATT	WATT=4500
THREE PHASE	TRIFASE/THREEPHASE
NUMBER OF POLES	POLI/POLES=6
NUMBER OF HOLES	FORI/HOLES=3
GASKET	2101033
IMMERSION HEATING ELEMENTS	IMMERSIONE/IMMERSION

Manufacturer code

LAMBER SRL
BERTO'S SPA
COMENDA - ALI GROUP SRL A SOCIO UNICO
MBM- EUROTEC SRL -