

1101867

# HEATING ELEMENT 10200W L=400MM

Date: 26-12-2024

ORIGINAL  
**OSP**  
SPARE PARTS

## Technical data

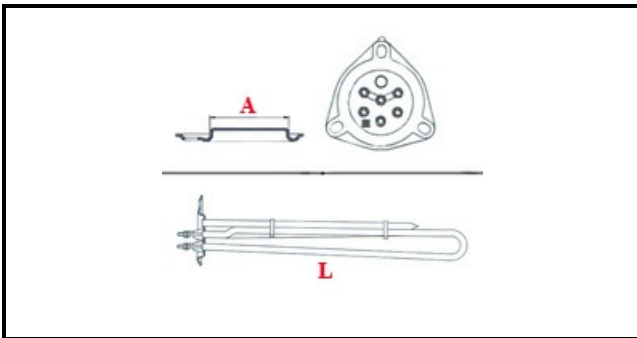

DEPTH MM	L=400mm
ELEMENTS	ELEMENTI/ELEMENTS=3
TRIANGULAR FLANGE	TRIANGOLARE/TRIANGULAR FLANGE=47mm
DIAMETER mm	A=47mm
KILOWATT KW	KW=10,2
WATT	WATT=10200
THREE PHASE	TRIFASE/THREEPHASE
NUMBER OF POLES	POLI/POLES=6
NUMBER OF HOLES	FORI/HOLES=3
GASKET	2101032
IMMERSION HEATING ELEMENTS	IMMERSIONE/IMMERSION

## Manufacturer code

MODULAR PROFESSIONAL SRL