

1201171

TANK HEATING ELEMENT 2000W-230V 1

Date: 28-11-2024



Technical data

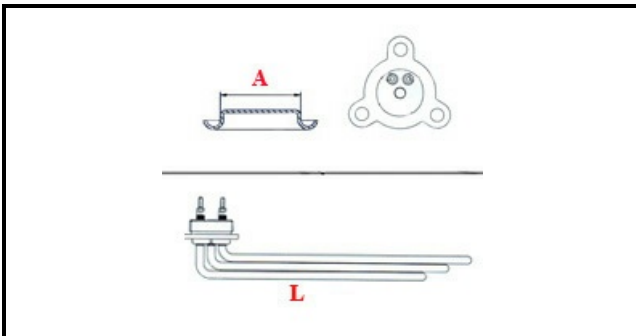

DEPTH MM	L=335mm
HEIGHT MM	H=30mm
ELEMENTS	ELEMENTI/ELEMENTS=1
ROUND FLANGE	TONDA/ROUND FLANGE=47mm
DIAMETER mm	A=47mm
KILOWATT KW	KW=2
WATT	WATT=2000
MONOPHASE	MONOFASE/MONOPHASE
NUMBER OF POLES	POLI/POLES=2
NUMBER OF HOLES	FORI/HOLES=3
GASKET	2101032
IMMERSION HEATING ELEMENTS	IMMERSIONE/IMMERSION ELEMENTS

Manufacturer code

MODULAR PROFESSIONAL SRL