

1106090

# TANK THERMOSTAT 53° SINGLE PHASE - SENSOR Ø 14X32 mm CAPILLARY 1000mm

Date: 27-02-2025

**ORIGINAL  
OSP  
SPARE PARTS**

## Technical data

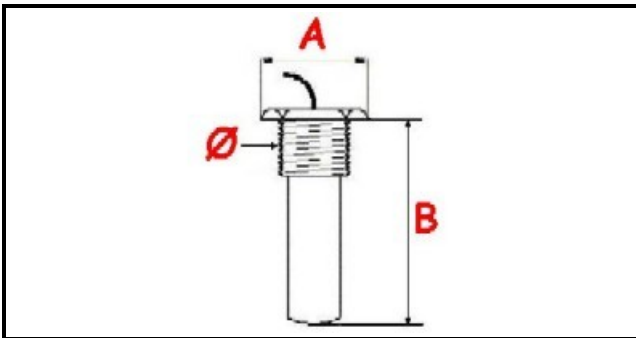

MONOPHASE	MONOFASE/MONOPHASE
GAS THREAD	Ø=14mm
NUMBER OF POLES	POLI/POLES=3
MAXIMUM TEMPERATURE °	T max=53°
WIRE mm	L=1000mm
PROBE DIAMETER MM	A=22mm
PROBE LENGHT MM	B=32mm

## Manufacturer code

ELETTROBAR EUROTEC SRL
MODULAR PROFESSIONAL SRL
GIGA GRANDI CUCINE SRL
ELETTROBAR EUROTEC SRL
MBM- EUROTEC SRL -
ELETTROBAR EUROTEC SRL
MBM- EUROTEC SRL -