

1101684

# HEATING ELEMENT W.3600 V.400 X P.D.450

Date: 26-12-2024

ORIGINAL  
**OSP**  
SPARE PARTS

## Technical data

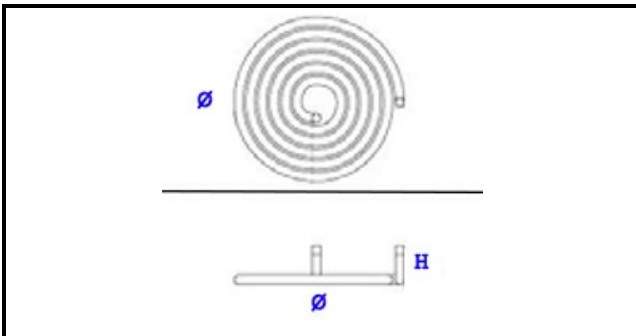

ELEMENTS	ELEMENTI/ELEMENTS=1
DIAMETER mm	Ø=450mm
KILOWATT KW	KW=3.6
WATT	WATT=3600
THREE PHASE	TRIFASE/THREEPHASE
NUMBER OF POLES	POLI/POLES=2
DRY HEATING ELEMENT	SECCO/DRY

## Manufacturer code

OEM - ALI GROUP SRL A SOCIO UNICO