

1106475

Date: 24-11-2024

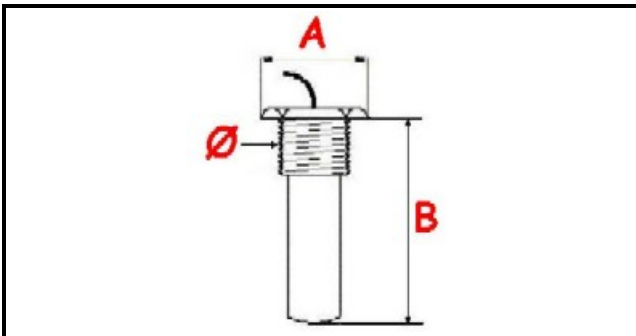

Technical data



MONOPHASE	MONOFASE/MONOPHASE
GAS THREAD	Ø=14mm
MAXIMUM TEMPERATURE °	T max=360°
WIRE mm	L=880mm
PROBE DIAMETER MM	A=25mm
PROBE LENGHT MM	B=12mm

Manufacturer code

LAINOX ALI GROUP SRL A SOCIO UNICO

OLIS ALI GROUP SRL A SOCIO UNICO

LAINOX ALI GROUP SRL A SOCIO UNICO