

1105003

CUP-WARMER SWITCH WITH LED

Date: 08-04-2025



ORIGINAL
OSP
SPARE PARTS

Technical data

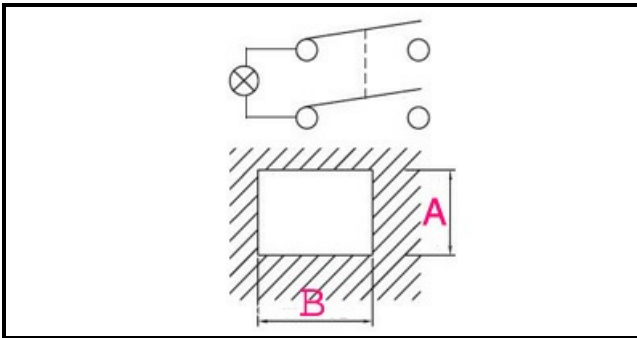

DEPTH MM	B=30mm
WIDTH MM	A=22mm
NUMBER OF POLES	POLI/POLES=4
NUMBER OF POSITIONS	0-1
COLOR	NERO CON LED/BLACK WITH LED
VOLT	250V

Manufacturer code

RANCILIO GROUP SPA CON SOCIO UNICO

MAGISTER SISTEMA CAFFE' SRL