

1101299

TANK HEATIN ELEMENT 8KW 230V+O-RING

Date: 24-11-2024

ORIGINAL
OSP
SPARE PARTS

Technical data

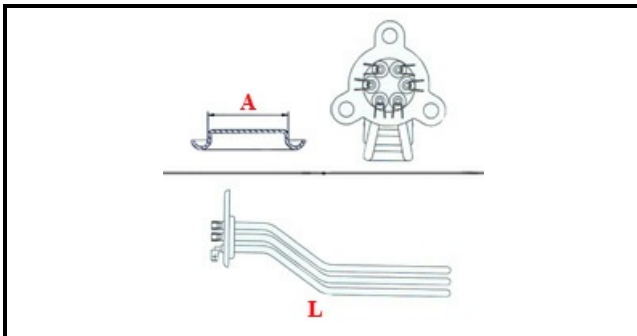

DEPTH MM	L=540mm
ELEMENTS	ELEMENTI/ELEMENTS=3
TRIANGULAR FLANGE	TRIANGOLARE/TRIANGULAR FLANGE=38mm
DIAMETER mm	A=38mm
KILOWATT KW	KW=8
WATT	WATT=8000
THREE PHASE	TRIFASE/THREEPHASE
NUMBER OF POLES	POLI/POLES=6
NUMBER OF HOLES	FORI/HOLES=3
GASKET	2101031
IMMERSION HEATING ELEMENTS	IMMERSIONE/IMMERSION

Manufacturer code

ANGELO PO GRANDI CUCINE SPA

SILANOS SRL