

1201143

HEATING ELEMENT 10KW 230V + OR

Date: 24-11-2024



Technical data

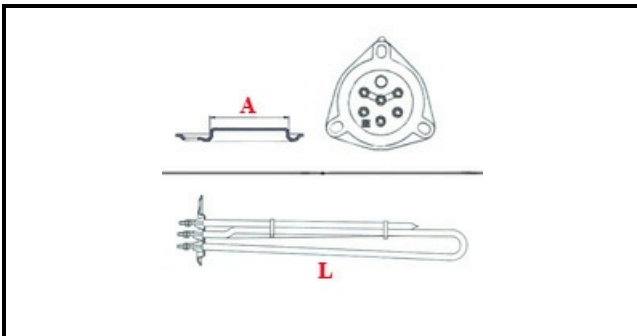

DEPTH MM	L=520mm
ELEMENTS	ELEMENTI/ELEMENTS=3
TRIANGULAR FLANGE	TRIANGOLARE/TRIANGULAR FLANGE=57mm
DIAMETER mm	A=57mm
KILOWATT KW	KW=10
WATT	WATT=10000
THREE PHASE	TRIFASE/THREEPHASE
NUMBER OF POLES	POLI/POLES=3
NUMBER OF HOLES	FORI/HOLES=3
GASKET	2101033
IMMERSION HEATING ELEMENTS	IMMERSIONE/IMMERSION

Manufacturer code

SILANOS SRL