

1101013

HEATING ELEMENT 4500W ATA

Date: 09-04-2025



ORIGINAL
OSP
SPARE PARTS

Technical data

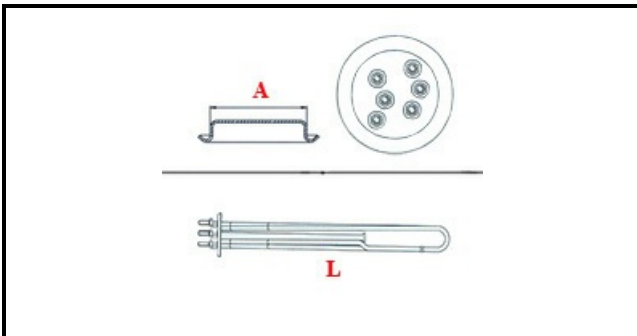

DEPTH MM	L=370mm
ELEMENTS	ELEMENTI/ELEMENTS=3
ROUND FLANGE	FLANGIA TONDA/ROUND FLANGE=47mm
DIAMETER mm	A=48mm
KILOWATT KW	KW=4,5
WATT	W=4500
THREE PHASE	TRIFASE/THREEPHASE
NUMBER OF POLES	POLI/POLES=6
GASKET	2101032
IMMERSION HEATING ELEMENTS	IMMERSIONE/IMMERSION

Manufacturer code

A.T.A. SRL