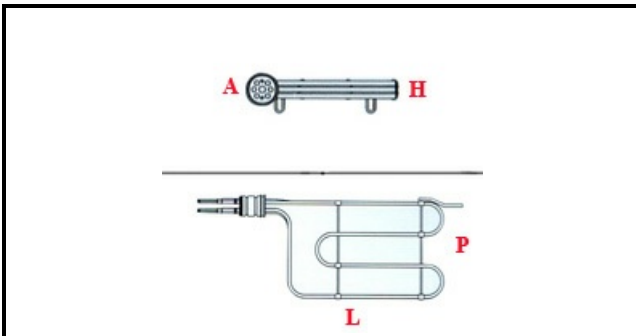

1101030

COOKER HEATING ELEMENT 8,5KW 230V

Date: 22-12-2024

ORIGINAL
OSP
SPARE PARTS**Technical data**

DEPTH MM	L=410mm
WIDTH MM	P=220mm
ELEMENTS	ELEMENTI/ELEMENTS=3
ROUND FLANGE	TONDA/ROUND FLANGE=40mm
DIAMETER mm	A=40mm
KILOWATT KW	KW=8,5
WATT	W=8500
THREE PHASE	TRIFASE/THREEPHASE
GAS THREAD	1"1/4
NUMBER OF POLES	POLI/POLES=6
GASKET	2101569
IMMERSION HEATING ELEMENTS	IMMERSIONE/IMMERSION
THREADED FLANGE	1"1/4

Manufacturer code

SILKO ALI GROUP SRL A SOCIO UNICO

MARENO ALI GROUP SRL A SOCIO UNICO