

1101037

## HEATING ELEMENT WEGA 1 GR 1800W

Date: 15-11-2024



### Technical data

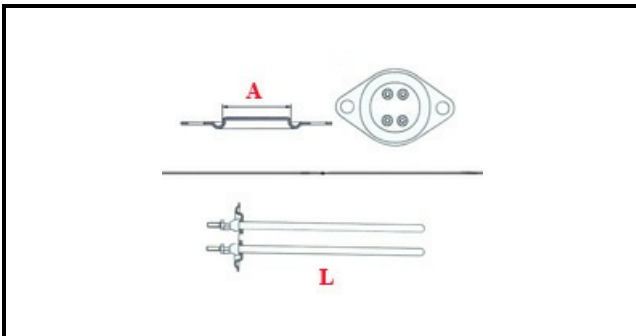

DEPTH MM	L=170mm
ELEMENTS	ELEMENTI/ELEMENTS=2
ROUND FLANGE	TONDA/ROUND FLANGE=42mm
DIAMETER mm	A=42mm
KILOWATT KW	KW=1,8
WATT	W=1800
MONOPHASE	MONOFASE/MONOPHASE
NUMBER OF POLES	POLI/POLES=4
NUMBER OF HOLES	FORI/HOLES=2
GASKET	2102130
IMMERSION HEATING ELEMENTS	IMMERSIONE/IMMERSION