

1101074

# HEATING ELEMENT ZANUSSI 076035

Date: 27-01-2025



ORIGINAL  
**OSP**  
SPARE PARTS

## Technical data

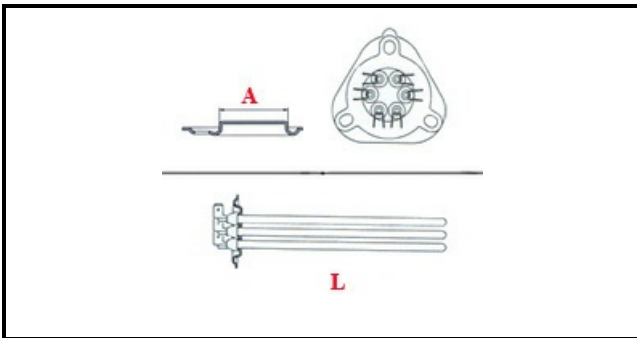

DEPTH MM	L=300mm
WIDTH MM	A=47mm
ELEMENTS	ELEMENTI/ELEMENTS=3
TRIANGULAR FLANGE	TRIANGOLARE/TRIANGULAR FLANGE=47mm
DIAMETER mm	A=47mm
KILOWATT KW	KW=6
WATT	WATT=6000
THREE PHASE	TRIFASE/THREEPHASE
NUMBER OF POLES	POLI/POLES=6
NUMBER OF HOLES	FORI/HOLES=3
GASKET	2101032
IMMERSION HEATING ELEMENTS	IMMERSIONE/IMMERSION

## Manufacturer code

ELECTROLUX PROFESSIONAL S.P.A.
ELECTROLUX PROFESSIONAL S.P.A.
ELECTROLUX PROFESSIONAL S.P.A.