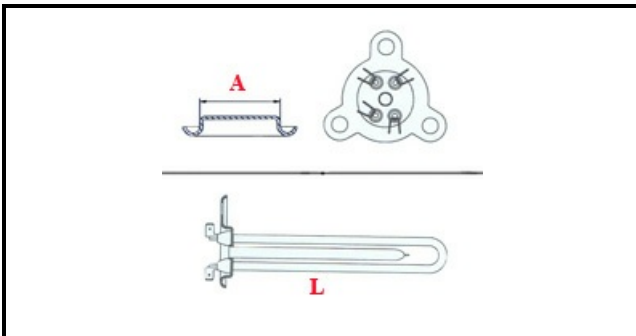

1101120

HEATING ELEMENT 3000W 230V D.38 2 EL.

Date: 27-02-2025

**Technical data**

DEPTH MM	L=285mm
ELEMENTS	ELEMENTI/ELEMENTS=2
TRIANGULAR FLANGE	TRIANGOLARE/TRIANGULAR FLANGE=38mm
DIAMETER mm	A=38mm
KILOWATT KW	KW=3
WATT	WATT=3000
MONOPHASE	MONOFASE/MONOPHASE
NUMBER OF POLES	POLI/POLES=4
NUMBER OF HOLES	FORI/HOLES=3
GASKET	2101031
IMMERSION HEATING ELEMENTS	IMMERSIONE/IMMERSION