

1101292

HEATING ELEMENT 3000W 3L FL58

Date: 23-02-2025

**ORIGINAL
OSP
SPARE PARTS**

Technical data

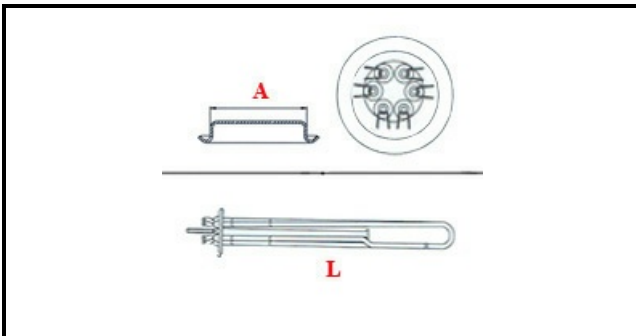

DEPTH MM	L=270mm
ELEMENTS	ELEMENTI/ELEMENTS=3
ROUND FLANGE	TONDA/ROUND FLANGE=47mm
DIAMETER mm	A=47mm
KILOWATT KW	KW=3
WATT	WATT=3000
THREE PHASE	TRIFASE/THREEPHASE
NUMBER OF POLES	POLI/POLES=6
GASKET	2101032
IMMERSION HEATING ELEMENTS	IMMERSIONE/IMMERSION

Manufacturer code

DIHR - ALI GROUP SRL A SOCIO UNICO
A.T.A. SRL