

1101297

# HEATING ELEMENT 2700W 230/400V

Date: 22-12-2024

ORIGINAL  
**OSP**  
SPARE PARTS

## Technical data

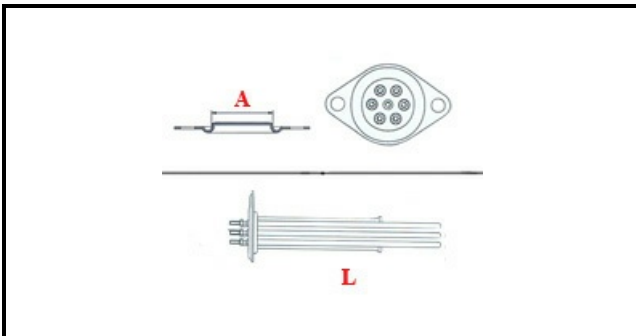

DEPTH MM	L=210mm
ELEMENTS	ELEMENTI/ELEMENTS=3
ROUND FLANGE	TONDA/ROUND FLANGE=43mm
DIAMETER mm	A=43mm
KILOWATT KW	KW=2,7
WATT	WATT=2700
THREE PHASE	TRIFASE/THREEPHASE
NUMBER OF POLES	POLI/POLES=6
NUMBER OF HOLES	FORI/HOLES=2
GASKET	2102130
IMMERSION HEATING ELEMENTS	IMMERSIONE/IMMERSION

## Manufacturer code

MAGISTER SISTEMA CAFFE' SRL