

1101298

HEATING ELEMENT 4000W

Date: 15-11-2024



Technical data

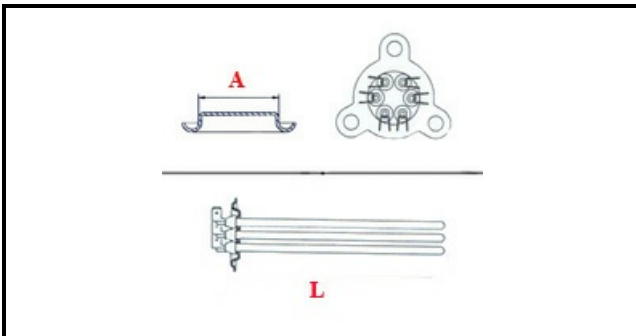

DEPTH MM	L=300mm
ELEMENTS	ELEMENTI/ELEMENTS=3
TRIANGULAR FLANGE	TRIANGOLARE/TRIANGULAR FLANGE=38mm
DIAMETER mm	A=38mm
KILOWATT KW	KW=4
WATT	WATT=4000
THREE PHASE	TRIFASE/THREEPHASE
NUMBER OF POLES	POLI/POLES=6
NUMBER OF HOLES	FORI/HOLES=3
GASKET	2101031
IMMERSION HEATING ELEMENTS	IMMERSIONE/IMMERSION

Manufacturer code

DIHR - ALI GROUP SRL A SOCIO UNICO