

1101378

HEATING ELEMENT 4500W 230V

Date: 22-01-2025

ORIGINAL
OSP
SPARE PARTS

Technical data

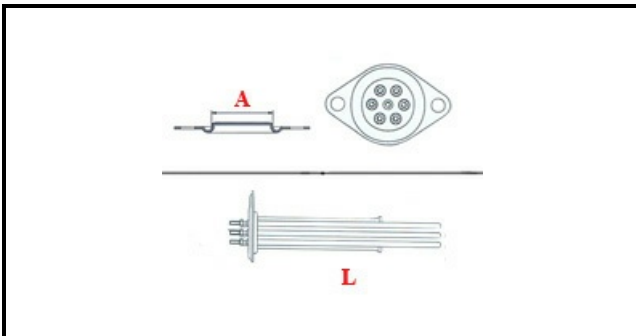

DEPTH MM	L=350mm
ELEMENTS	ELEMENTI/ELEMENTS=3
ROUND FLANGE	TONDA/ROUND FLANGE=43mm
DIAMETER mm	A=43mm
KILOWATT KW	KW=4,5
WATT	WATT=4500
THREE PHASE	TRIFASE/THREEPHASE
NUMBER OF POLES	POLI/POLES=6
NUMBER OF HOLES	FORI/HOLES=2
GASKET	2102935
IMMERSION HEATING ELEMENTS	IMMERSIONE/IMMERSION

Manufacturer code

MAGISTER SISTEMA CAFFE' SRL