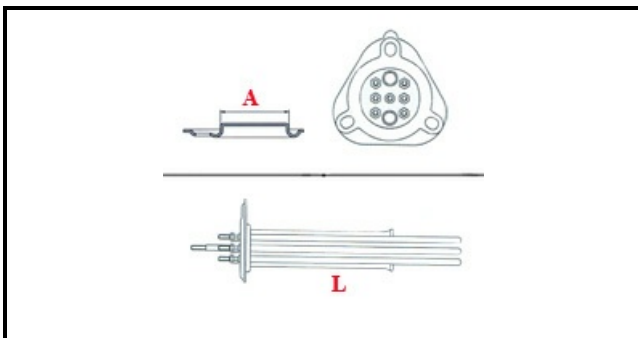

1101403

BOILER HEATING ELEMENT 230V 8800W

Date: 29-01-2025

**Technical data**

DEPTH MM	L=550mm
ELEMENTS	ELEMENTI/ELEMENTS=3
TRIANGULAR FLANGE	TRIANGOLARE/TRIANGULAR FLANGE=47mm
DIAMETER mm	A=47mm
KILOWATT KW	KW=8
WATT	WATT=8000
THREE PHASE	TRIFASE/THREEPHASE
NUMBER OF POLES	POLI/POLES=6
NUMBER OF HOLES	FORI/HOLES=3
GASKET	2101032
IMMERSION HEATING ELEMENTS	IMMERSIONE/IMMERSION

Manufacturer code

LASA SRL