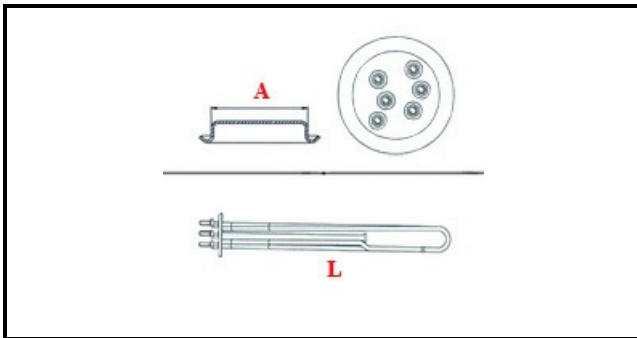

1101410

BOILER HEATING ELEMENT 3X2000W 230V

Date: 15-11-2024

ORIGINAL
OSP
SPARE PARTS**Technical data**

DEPTH MM	L=460mm
ELEMENTS	ELEMENTI/ELEMENTS=3
ROUND FLANGE	TONDA/ROUND FLANGE=57mm
DIAMETER mm	A=57mm
KILOWATT KW	KW=6
WATT	WATT=6000
THREE PHASE	TRIFASE/THREEPHASE
NUMBER OF POLES	POLI/POLES=6
GASKET	2101033
IMMERSION HEATING ELEMENTS	IMMERSIONE/IMMERSION

Manufacturer code

ELECTROLUX PROFESSIONAL S.P.A.

ELECTROLUX PROFESSIONAL S.P.A.