

1101452

HEATING ELEMENT 2GR 6P 4500W 230/380V

Date: 06-04-2025



ORIGINAL
OSP
SPARE PARTS

Technical data

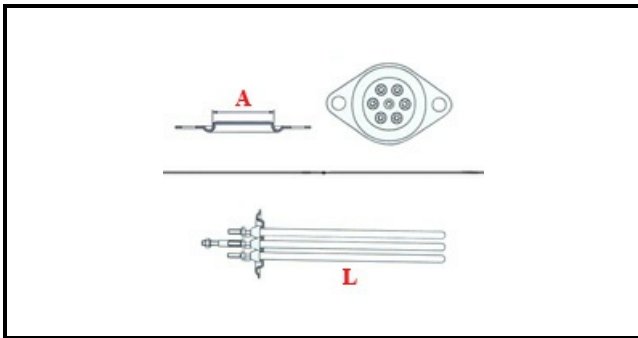

ELEMENTS	ELEMENTI/ELEMENTS=3
ROUND FLANGE	TONDA/ROUND FLANGE=42mm
DIAMETER mm	A=42mm
KILOWATT KW	KW=4,5
WATT	WATT=4500
THREE PHASE	TRIFASE/THREEPHASE
NUMBER OF POLES	POLI/POLES=6
NUMBER OF HOLES	FORI/HOLES=2
GASKET	2102130
IMMERSION HEATING ELEMENTS	IMMERSIONE/IMMERSION ELEMENTS

Manufacturer code

CMA MACCHINE PER CAFFE' SRL