

1101506

SAFETY HEATING ELEMENT 400V 6,0 KW

Date: 04-04-2025



ORIGINAL
OSP
SPARE PARTS

Technical data

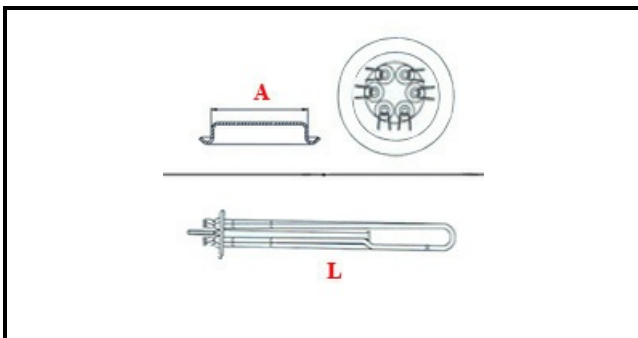

DEPTH MM	L=290mm
ELEMENTS	ELEMENTI/ELEMENTS=3
ROUND FLANGE	TONDA/ROUND FLANGE=47mm
DIAMETER mm	A=47mm
KILOWATT KW	KW=6
WATT	WATT=6000
THREE PHASE	TRIFASE/THREEPHASE
NUMBER OF POLES	POLI/POLES=6
GASKET	2101032
IMMERSION HEATING ELEMENTS	IMMERSIONE/IMMERSION

Manufacturer code

WINTERHALTER ITALIA SRL
WINTERHALTER ITALIA SRL
WINTERHALTER ITALIA SRL
WINTERHALTER ITALIA SRL