

1101509

Date: 22-12-2024

**ORIGINAL
OSP
SPARE PARTS**

Technical data

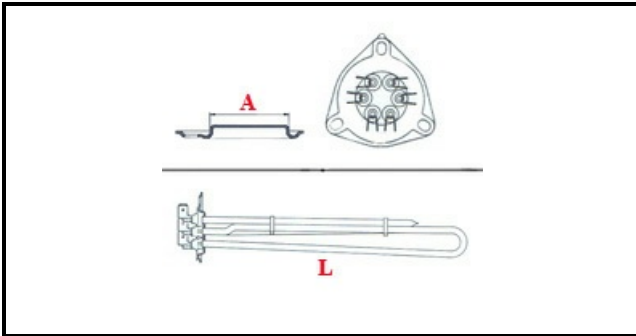

DEPTH MM	L=345mm
ELEMENTS	ELEMENTI/ELEMENTS=3
TRIANGULAR FLANGE	TRIANGOLARE/TRIANGULAF FLANGE=57mm
DIAMETER mm	A=57mm
KILOWATT KW	KW=5
WATT	WATT=5000
THREE PHASE	TRIFASE/THREEPHASE
NUMBER OF POLES	POLI/POLES=6
NUMBER OF HOLES	FORI/HOLES=3
GASKET	2101033
IMMERSION HEATING ELEMENTS	IMMERSIONE/IMMERSION

Manufacturer code

COMENDA - ALI GROUP SRL A SOCIO UNICO